

## Electromechanical Post Swing Gate Operators: Model T4010 / T4010F (230 VAC)

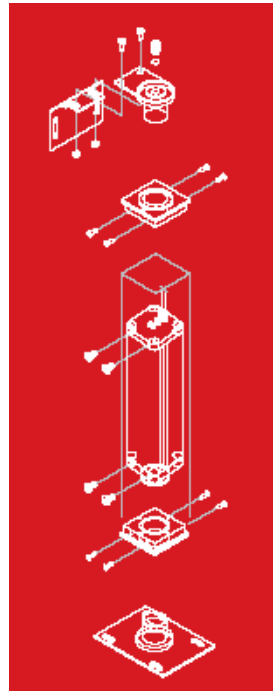

- Operator to built in the framework of a Swing Gate
- Fittings and hinges designed for iron and aluminium Gates.
- Unlimited opening angle
- Sealed installation and watertight motor
- For Swing Gates up to 2.5 meters per leaf.
- For residential applications (20 cycles per hour).  
Self locking with emergency manual release system and none self locking version.
- Easy Installation
- Encoder: learn gate travel, adjustable anti-crush protection
- Through control unit: Partial Opening, slow down to reduce impact when gate meets stop, torque adjustment, lag time adjusting, pause time adjusting, light time adjusting, safety devices connection,...
- Advantages comparing with underground systems:
  - Savings on installation costs.
  - No problems with water
  - No foundation boxes, no drain installation

# Electromechanical Post Swing Gate Operators: Model T4010 / T4010F (230 VAC)



**T4010**  
(None self locking – reversible version)



**T4010F**  
(Self Locking version)

	T4010	T4010F	T4011P	T4000VFIP
Absorbed power	220 W	220 W	220 W	220 W
Max.Use Frequency	40%	40%	60%	40%
Capacitor	4 uf	4 uf	4 uf	4 uf
Protection Class	IP54	IP54	IP54	IP54
Motor supply	230 VAC	230 VAC	230 VAC	230 VAC
Opening time (90°)	12 sec	12 sec	7 sec	7 sec
Operating temperature	(-) 25 (+) 70°C	(-) 25 (+) 70°C	(-) 25 (+) 70°C	(-) 25 (+) 70°C
Operator weight	10 kg	10 kg	10 kg	10 kg
Torque	205 Nm	205 Nm		
Max. Gate leaf Weight	500 kg	500 kg	80 kg	80 kg
Max. Gate leaf lenght	2,5 m	1,8 m	1,2 m	1,2 m
Manual release system	Electro-lock	Yes, cylinder key	Electro-lock	Yes, cylinder key
Oil bath	No	NO	YES	NO
Encoder	YES	YES	YES	YES

- ❶ INSTALATION
- ❷ CONTROL UNIT FOR AC SWING GATE OPERATORS
- ❸ KITS



1x AEP20TOP  
Control panel

# Electromechanical Post Swing Gate Operators: Model T4010 / T4010F (230 VAC)

## Mounting the Unit

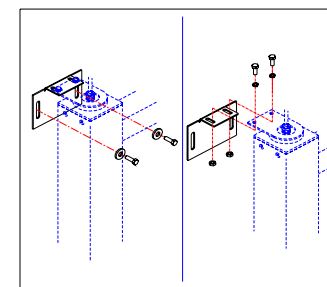
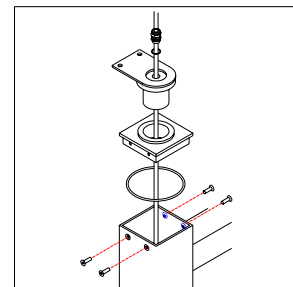
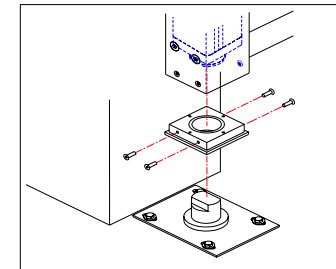
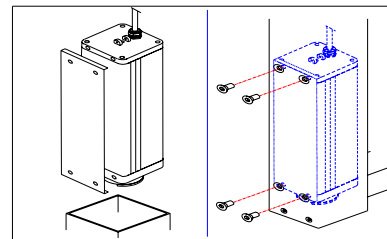
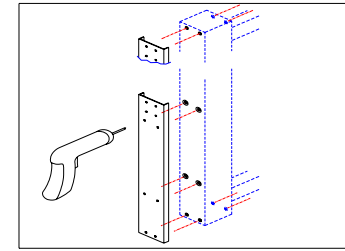
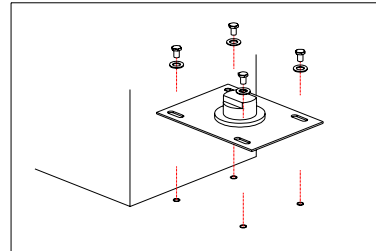
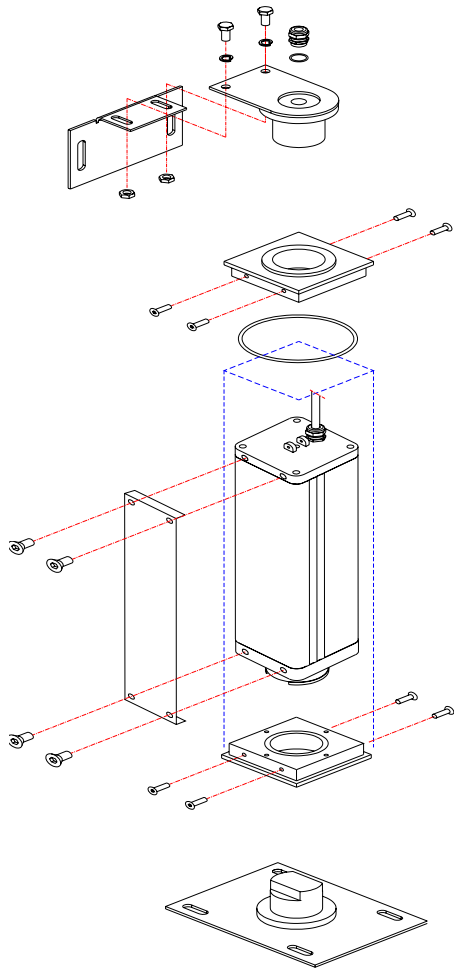





# EXAMPLES:



## Model T4010 / T4010F (230 VAC). Uses

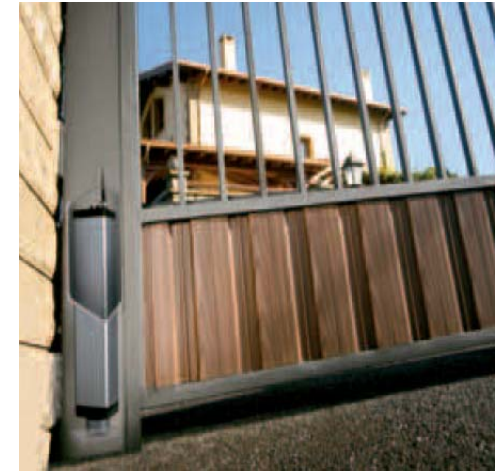

Since year 1989

Up and Over Door Motor T4010

Since year 2000

Articulated arm Swing Gate Motor T4010

Since year 2006

Built in Post Swing Gate Motor T4010

